

Schnitt B-B

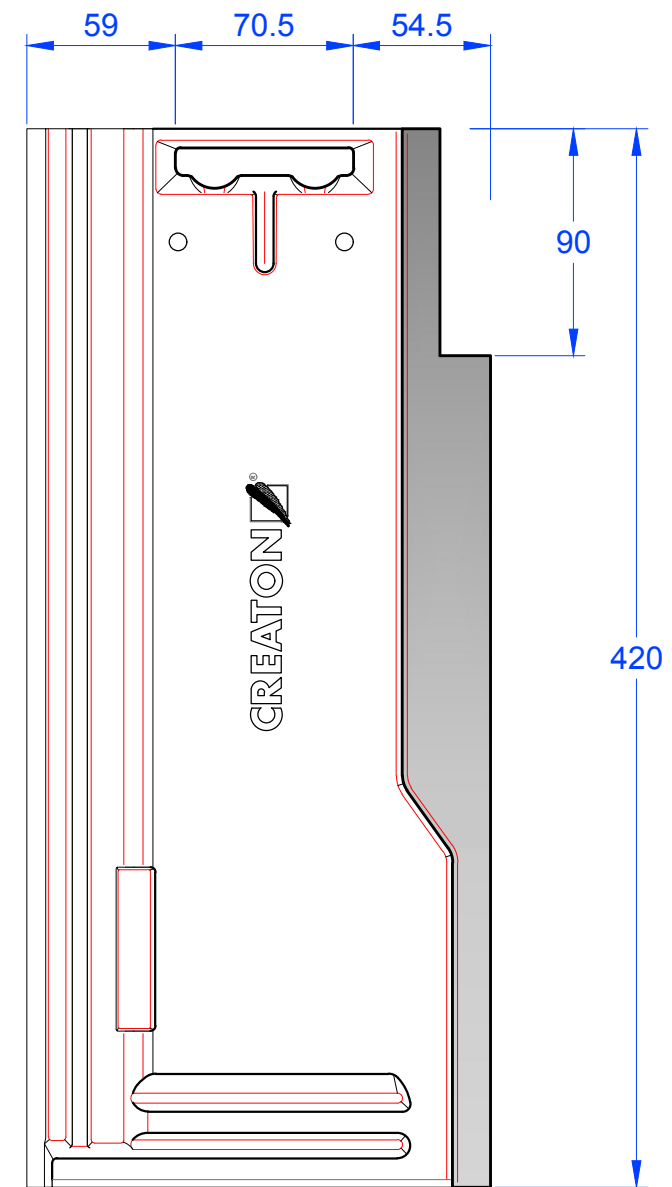

Schnitt A-A

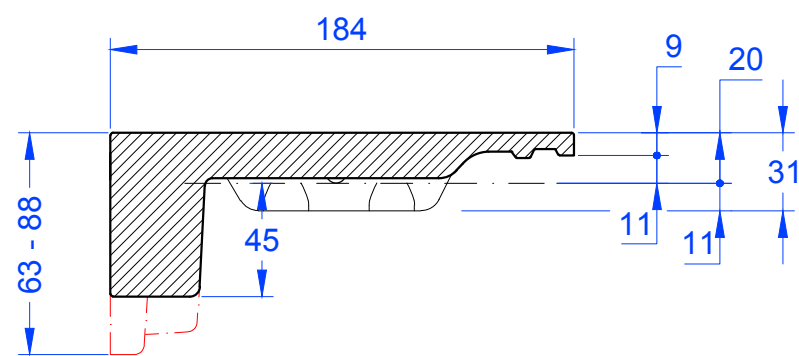

MAßSTAB: 1:3 bei DIN-A3	
Änderungen vorbehalten	
STAND: 25.08.2016 Rs	PRODUKT: "KAPSTADT" Ortgang-Längshalber Links, Ausstich 90mm
Maßangaben können aufgrund von Schwund-Toleranzen variieren	